

$$\text{glass height} = (\text{opening} + 44\text{mm}) / 2$$

aneeta inserts suit a variety of manufacturers door types, but only commercial grade doors are recommended
(i.e. with corner spigets or tie rods to limit door movement)

Rev	Description	Approved	
		By	Date
D	Updated with new template, deleted continuous handle, added new lock	SE	Jan2024
C	Changed lock, pulley positions, sill & drawing layout	RL	Jun2013
B	Added VS 6mm head	SB	Feb2011
A	Original issue	UF	Jan2010

Proprietary and confidential
The information contained in this drawing is the sole property of Aneeta Australia. Any reproduction in part or as a whole, without the written permission of Aneeta Australia is prohibited.

Title:
2 pane 6mm sashless vertical sliders in aluminium doors SS hinged door vertical section A-A

Drwn: UF | Chk: - | Date: Jan 2010 | Scale: 1:2@A4



949 Stud Road, Rowville VIC 3178, ABN 80 062 883 729

Sheet 1 of 6 | Revision: D

Material:	in Aluminium frame
Finish:	-
Die/Part:	-
Dwg No:	VSD 2P6 SS A

N:\Corporate\TECHNICAL\Drawing Files\Aneeta product CAD drawings\VSD DOORS\VSD 2P6 SS A (D).dwg

IF IN DOUBT ASK - DO NOT SCALE DRAWING

glass width = opening - 40mm

aneeta opening size

flyscreen (optional by others)

6mm combination tee

top pane

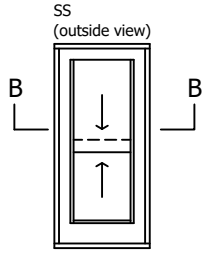

outside

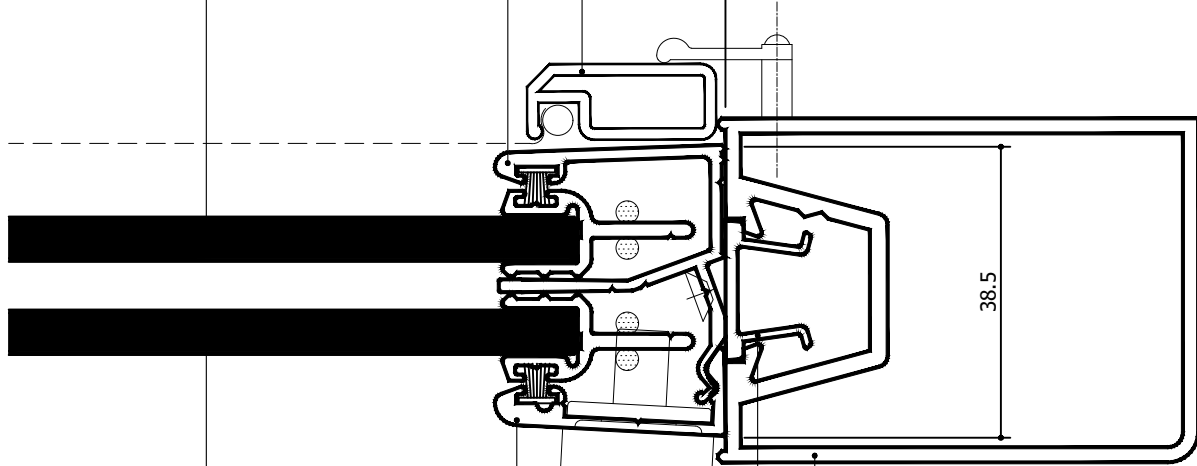

inside

bottom pane

aluminium cover

lock

flush filler (by others)

door stile (by others)

aneeta inserts suit a variety of manufacturers door types, but only commercial grade doors are recommended

(i.e. with corner spigets or tie rods to limit door movement)

Rev	Description	Approved	
		By	Date
D	Updated with new template, deleted continuous handle, added new lock	SE	Jan2024
C	Changed lock, pulley positions, sill & drawing layout	RL	Jun2013
B	Added VS 6mm head	SB	Feb2011
A	Original issue	UF	Jan2010

N:\Corporate\TECHNICAL\Drawing Files\Aneeta product CAD drawings\VS\DOORS\VSD 2P6 SS A (D).dwg

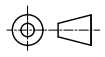

IF IN DOUBT ASK - DO NOT SCALE DRAWING

Proprietary and confidential The information contained in this drawing is the sole property of Aneeta Australia. Any reproduction in part or as a whole, without the written permission of Aneeta Australia is prohibited.	Title: 2 pane 6mm sashless vertical sliders in aluminium doors SS hinged door horizontal section B-B		 949 Stud Road, Rowville VIC 3178, ABN 80 062 883 729	Material: in Aluminium frame
	Drwn: UF Chk: - Date: Jan 2010 Scale: 1:1eA4			Finish: -
	Sheet 2 of 6			Die/Part: -
	Revision: D			Dwg No: VSD 2P6 SS A

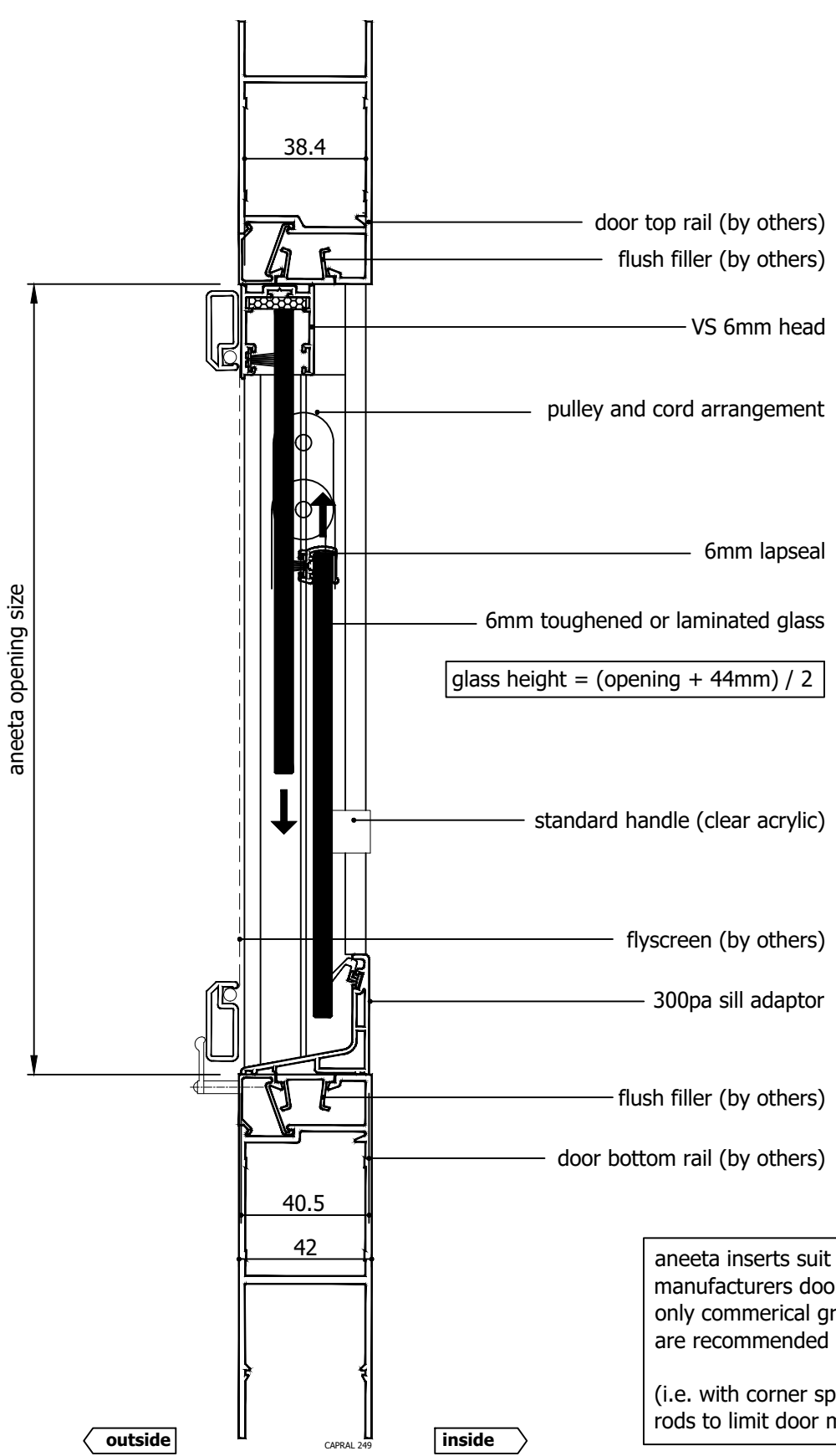
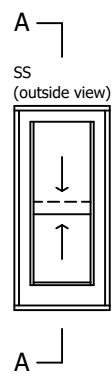

$$\text{glass height} = (\text{opening} + 44\text{mm}) / 2$$

aneeta inserts suit a variety of manufacturers door types, but only commercial grade doors are recommended
(i.e. with corner spigets or tie rods to limit door movement)

Rev	Description	Approved	
		By	Date
D	Updated with new template, deleted continuous handle, added new lock	SE	Jan2024
C	Changed lock, pulley positions, sill & drawing layout	RL	Jun2013
B	Added VS 6mm head	SB	Feb2011
A	Original issue	UF	Jan2010

Proprietary and confidential
The information contained in this drawing is the sole property of Aneeta Australia. Any reproduction in part or as a whole, without the written permission of Aneeta Australia is prohibited.

Title:
2 pane 6mm sashless vertical sliders in aluminium doors SS
bifold door
vertical section A-A
Drwn: UF | Chk: - | Date: Jan 2010 | Scale: 1:2@A4



949 Stud Road, Rowville VIC 3178, ABN 80 062 883 729
Sheet 3 of 6

Material:	in Aluminium frame
Finish:	-
Die/Part:	-
Dwg No:	VSD 2P6 SS A
Revision:	D

N:\Corporate\TECHNICAL\Drawing Files\Aneeta product CAD drawings\VSD DOORS\VSD 2P6 SS A (D).dwg

IF IN DOUBT ASK - DO NOT SCALE DRAWING

glass width = opening - 40mm

aneeta opening size

flyscreen (optional by others)

6mm combination tee

top pane

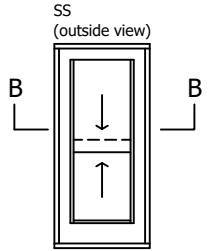

outside

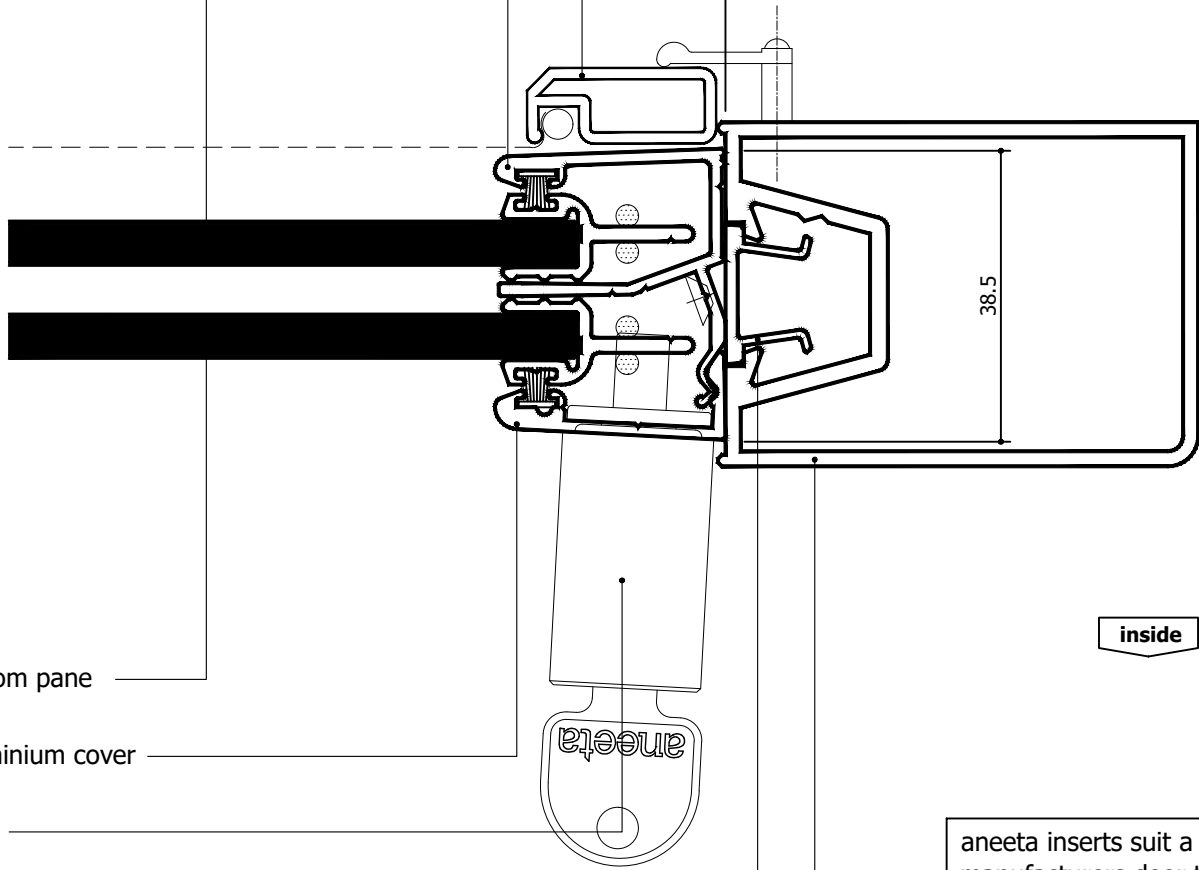

inside

bottom pane

aluminium cover

lock

flush filler (by others)

door stile (by others)

aneeta inserts suit a variety of manufacturers door types, but only commercial grade doors are recommended

(i.e. with corner spigets or tie rods to limit door movement)

Rev	Description	Approved	
		By	Date
D	Updated with new template, deleted continuous handle, added new lock	SE	Jan2024
C	Changed lock, pulley positions, sill & drawing layout	RL	Jun2013
B	Added VS 6mm head	SB	Feb2011
A	Original issue	UF	Jan2010

Proprietary and confidential
The information contained in this drawing is the sole property of Aneeta Australia. Any reproduction in part or as a whole, without the written permission of Aneeta Australia is prohibited.

Title:
2 pane 6mm sashless vertical sliders
in aluminium doors SS
bifold door
horizontal section B-B



949 Stud Road, Rowville VIC 3178, ABN 80 062 883 729

Drwn: UF Chk: - Date: Jan 2010 Scale: 1:1eA4 Sheet 4 of 6 Revision: D

Material: in Aluminium frame

Finish: -

Die/Part: -

Dwg No: VSD 2P6 SS A

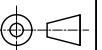

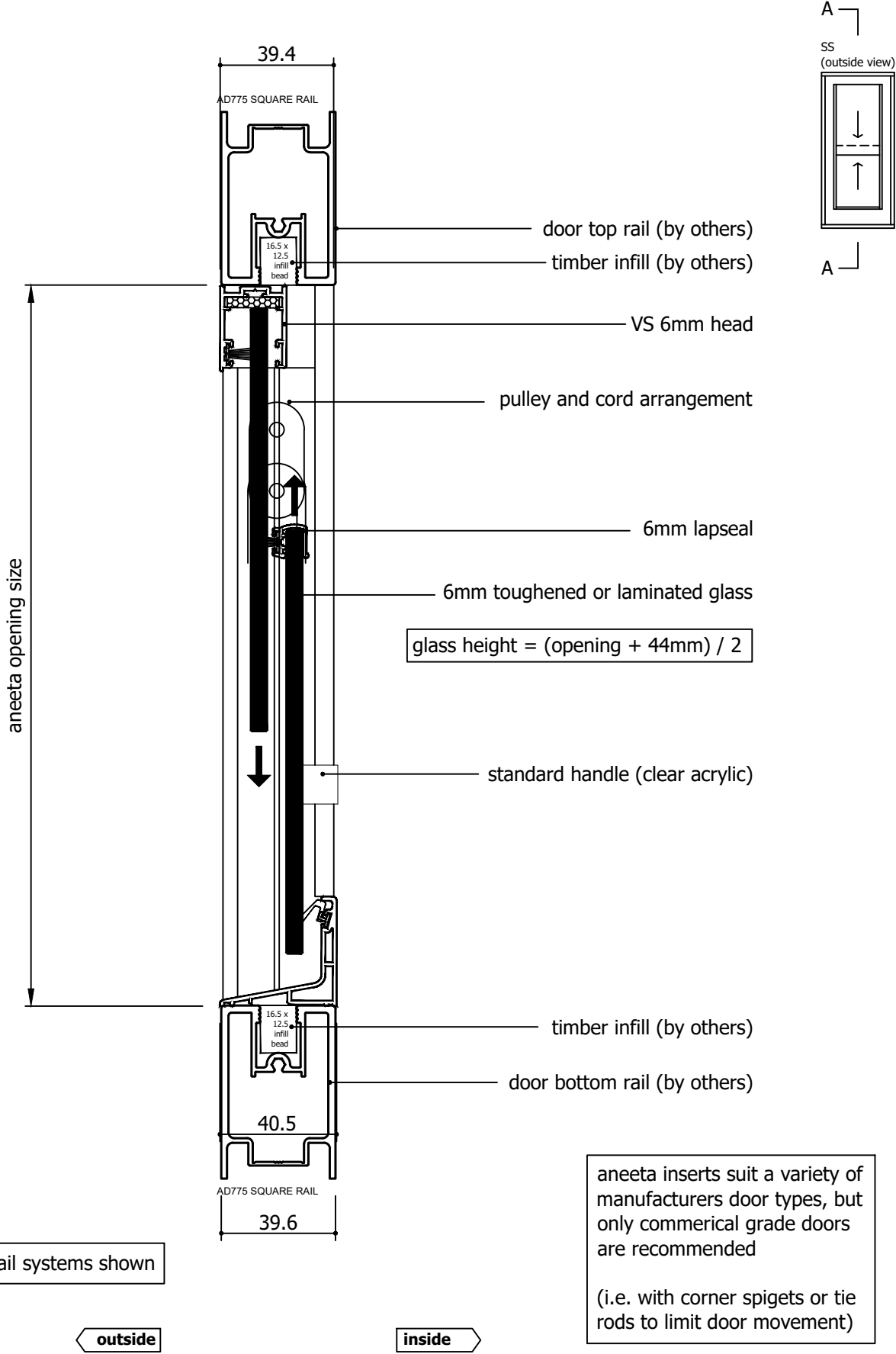

N:\Corporate\TECHNICAL\Drawing Files\Aneeta product CAD drawings\VSD DOORS\VSD 2P6 SS A (D).dwg

Rev	Description	Approved	
		By	Date
D	Updated with new template, deleted continuous handle, added new lock	SE	Jan2024
C	Changed lock, pulley positions, sill & drawing layout	RL	Jun2013
B	Added VS 6mm head	SB	Feb2011
A	Original issue	UF	Jan2010

Proprietary and confidential
 The information contained in this drawing is the sole property of Aneeta Australia. Any reproduction in part or as a whole, without the written permission of Aneeta Australia is prohibited.

Title:
2 pane 6mm sashless vertical sliders in aluminium doors SS sliding door vertical section A-A

Drwn: UF | Chk: - | Date: Jan 2010 | Scale: 1:20A4



949 Stud Road, Rowville VIC 3178, ABN 80 062 883 729

Sheet 5 of 6 | Revision: D

Material:	in Aluminium frame
Finish:	-
Die/Part:	-
Dwg No:	VSD 2P6 SS A

IF IN DOUBT ASK - DO NOT SCALE DRAWING

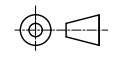

glass width = opening - 40mm

aneeta opening size

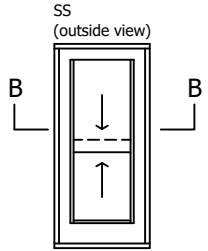

6mm combination tee

top pane

outside

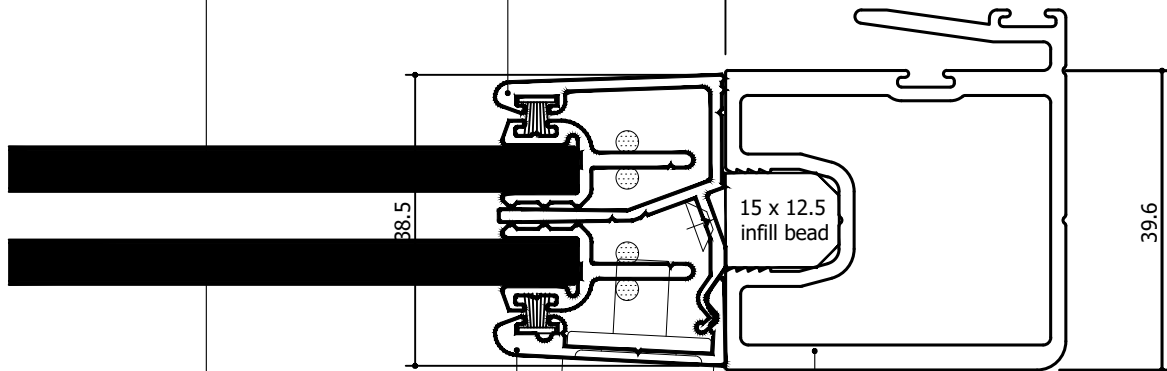

AD744 STANDARD MULLION

inside

bottom pane

aluminium cover

lock

door stile (by others)

aneeta inserts suit a variety of manufacturers door types, but only commercial grade doors are recommended

(i.e. with corner spigets or tie rods to limit door movement)

Rev	Description	Approved	
		By	Date
D	Updated with new template, deleted continuous handle, added new lock	SE	Jan2024
C	Changed lock, pulley positions, sill & drawing layout	RL	Jun2013
B	Added VS 6mm head	SB	Feb2011
A	Original issue	UF	Jan2010



IF IN DOUBT ASK - DO NOT SCALE DRAWING

Proprietary and confidential The information contained in this drawing is the sole property of Aneeta Australia. Any reproduction in part or as a whole, without the written permission of Aneeta Australia is prohibited.	Title: 2 pane 6mm sashless vertical sliders in aluminium doors SS sliding door horizontal section B-B	
	Drwn: UF Chk: - Date: Jan 2010 Scale: 1:1eA4	Sheet 6 of 6



949 Stud Road, Rowville VIC 3178, ABN 80 062 883 729

Material:	in Aluminium frame
Finish:	-
Die/Part:	-
Dwg No:	VSD 2P6 SS A

Revision: D