

4 pane 10mm horizontal slider 300 series in timber frames, 2 panes fixed

vertical section A-A

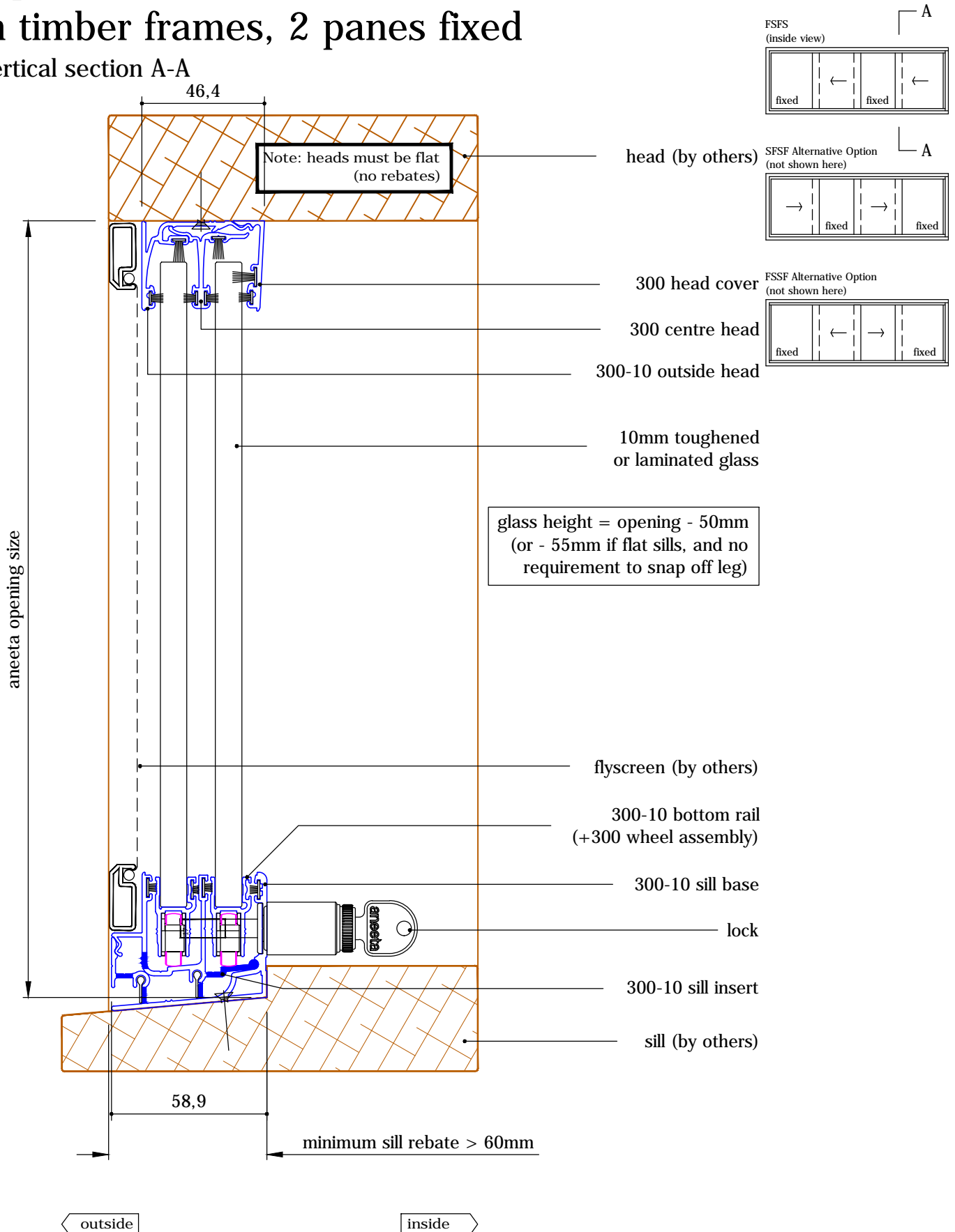

4 pane 10mm horizontal slider 300 series in timber frames, 2 panes fixed horizontal section B-B

drawing: HS300 4P10 FSFS T h
 revision: 2
 date: Jun 2013

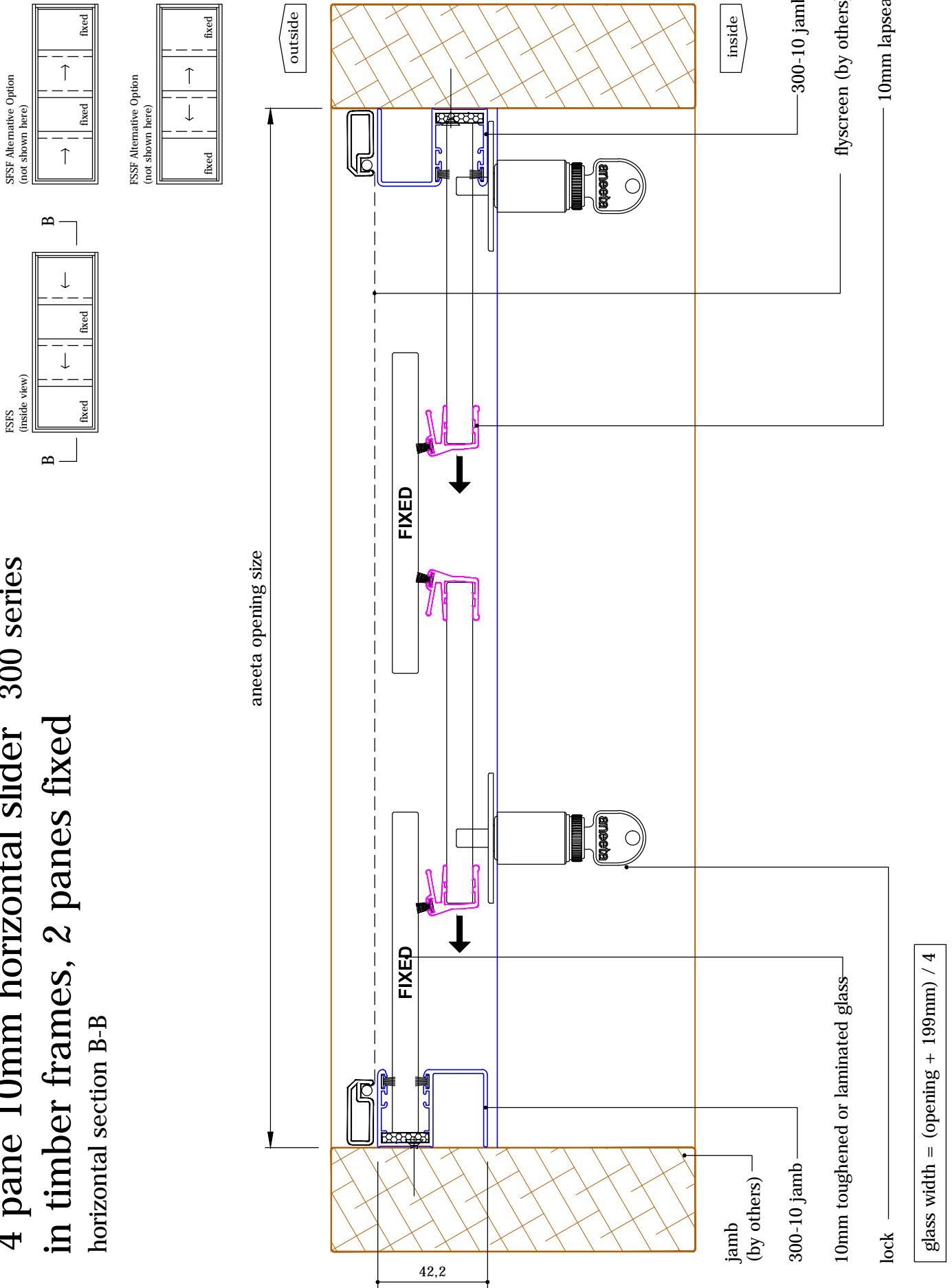

4 pane 10mm horizontal slider 300 series in timber frames, 2 panes fixed

vertical section A-A

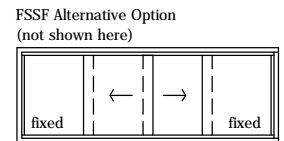
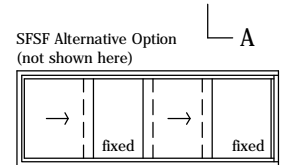
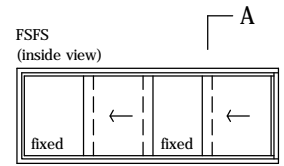
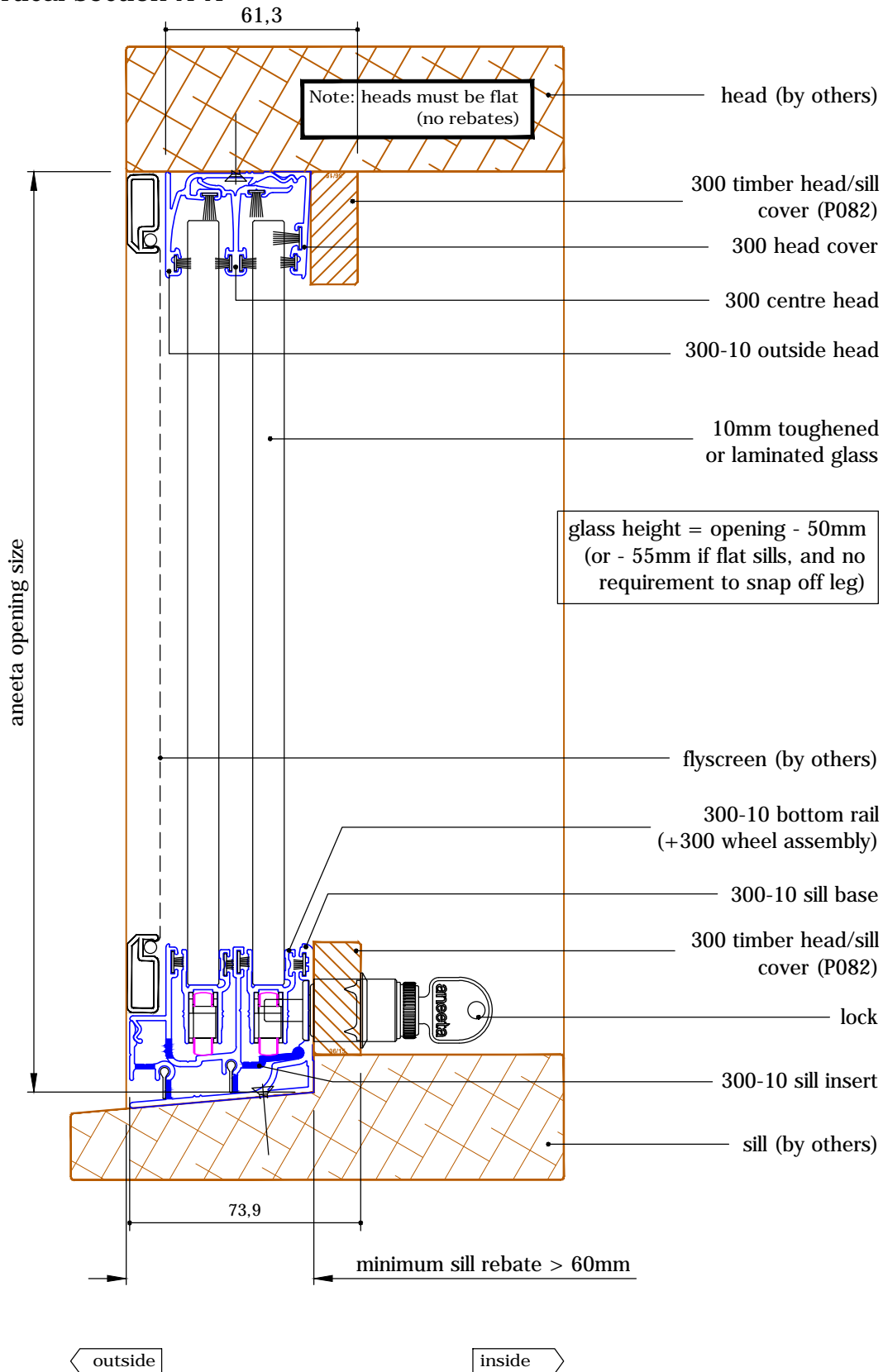

4 pane 10mm horizontal slider 300 series in timber frames, 2 panes fixed

horizontal section B-B

drawing: HS300 4P10 FSFS T h - timber cover option 1
 revision: 2
 date: Jun 2013

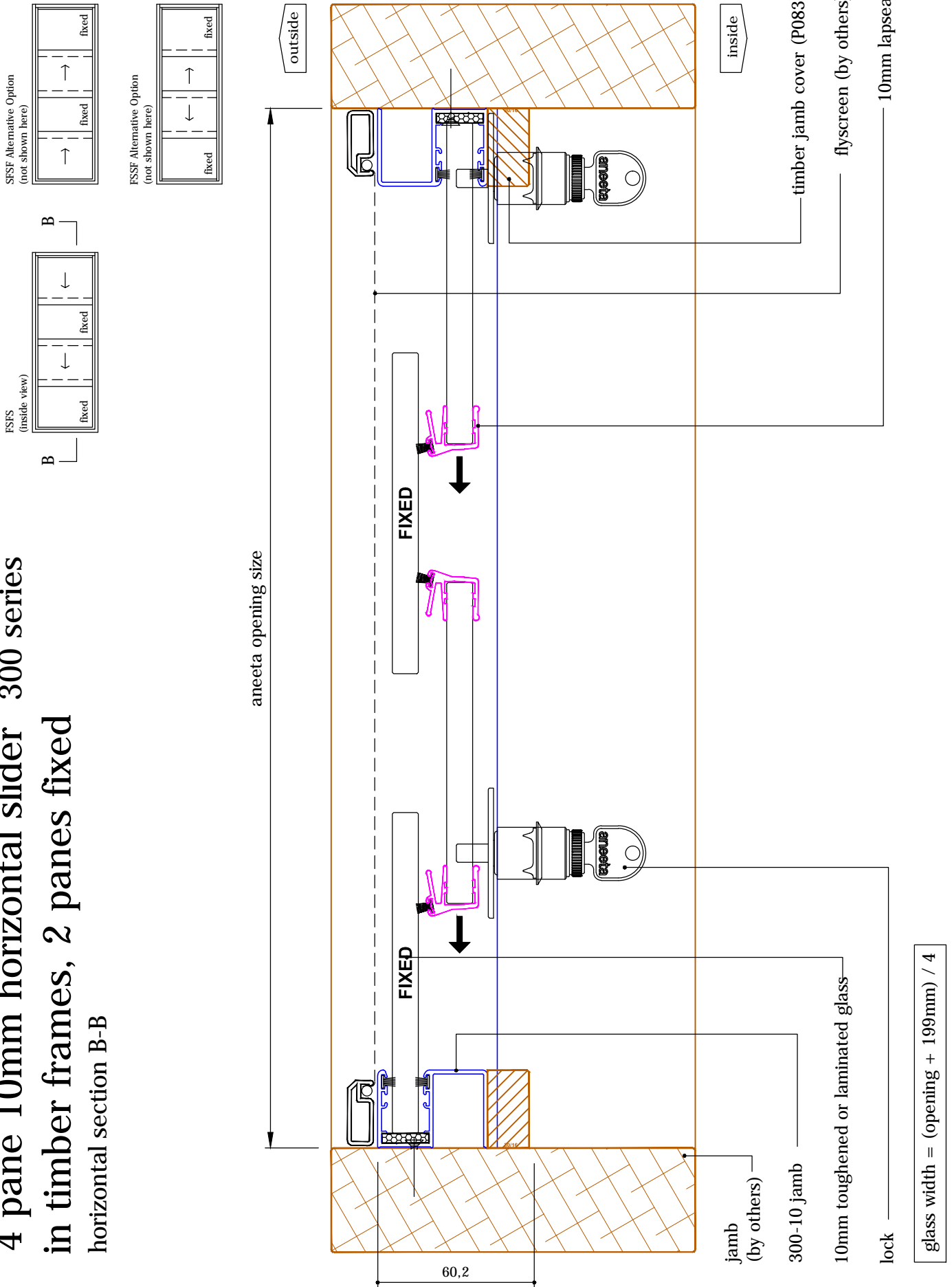

4 pane 10mm horizontal slider 300 series in timber frames, 2 panes fixed

vertical section A-A

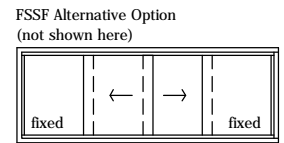
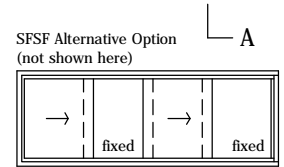
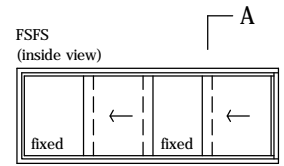
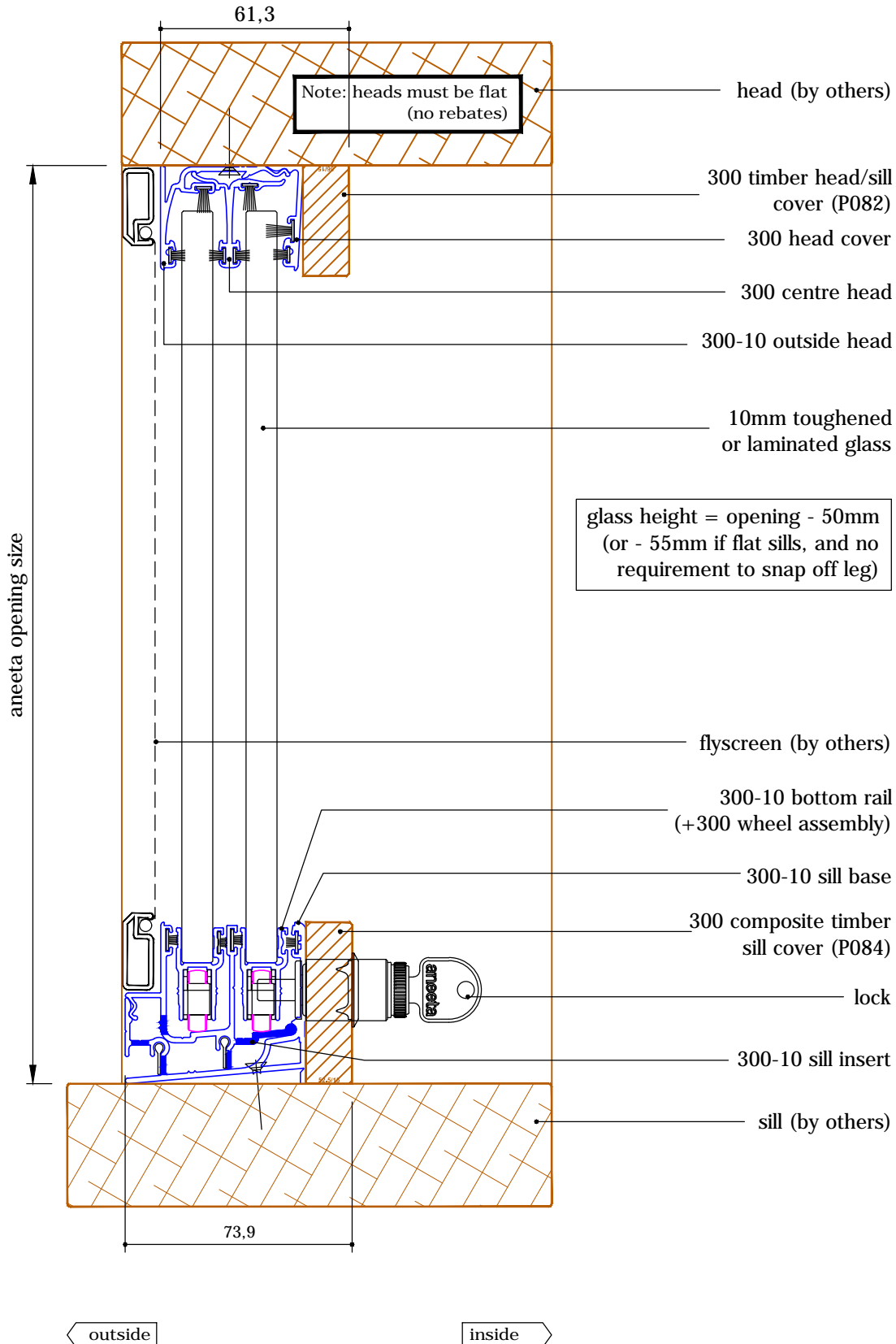

4 pane 10mm horizontal slider 300 series in timber frames, 2 panes fixed

horizontal section B-B

drawing: HS300 4P10 FSFS T h - timber cover option 2
 revision: 2
 date: Jun 2013

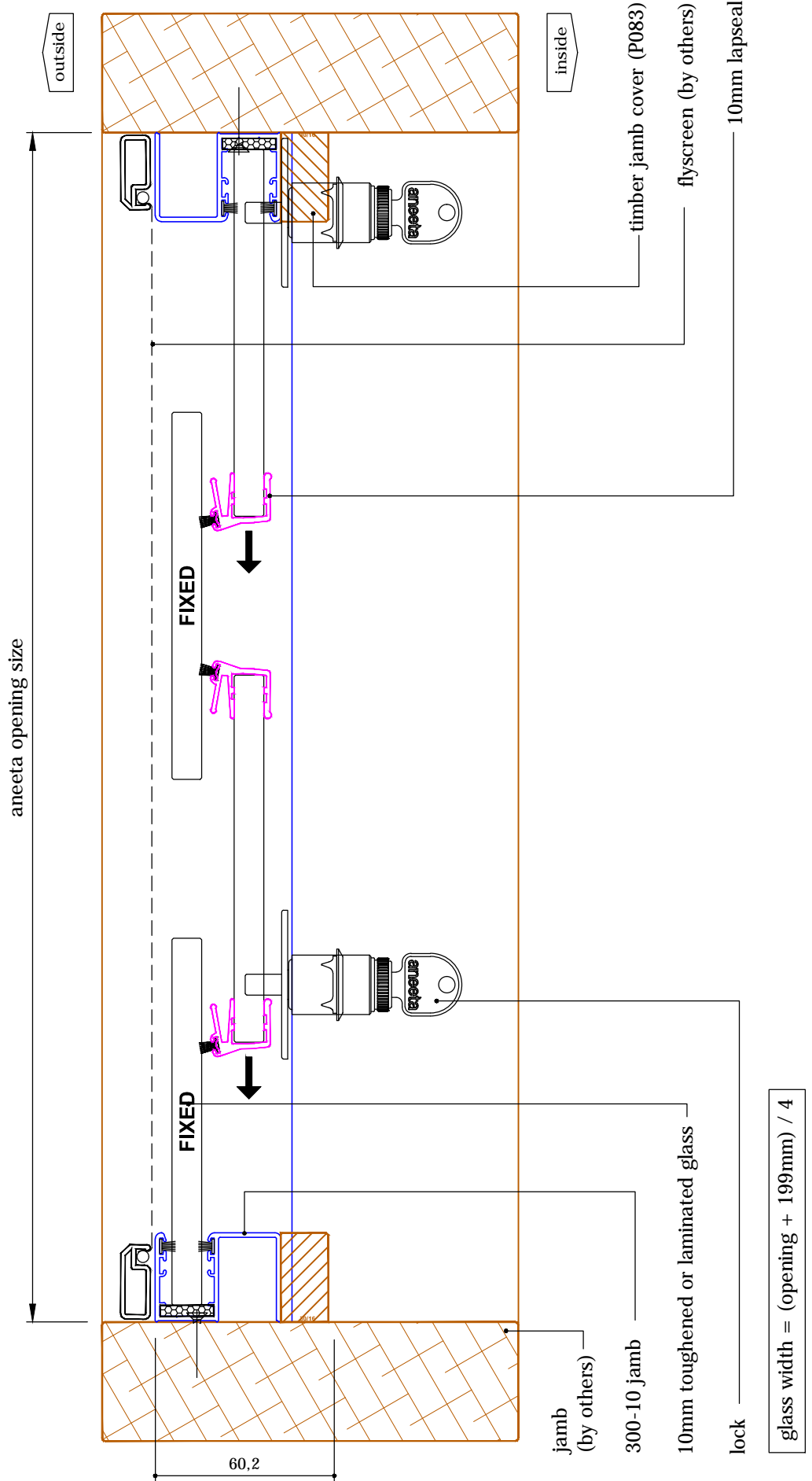
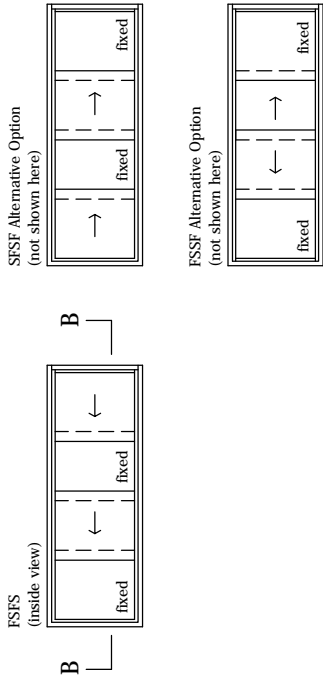

4 pane 10mm horizontal slider 300 series in timber frames, 2 panes fixed

vertical section A-A **INTERNAL USE ONLY**

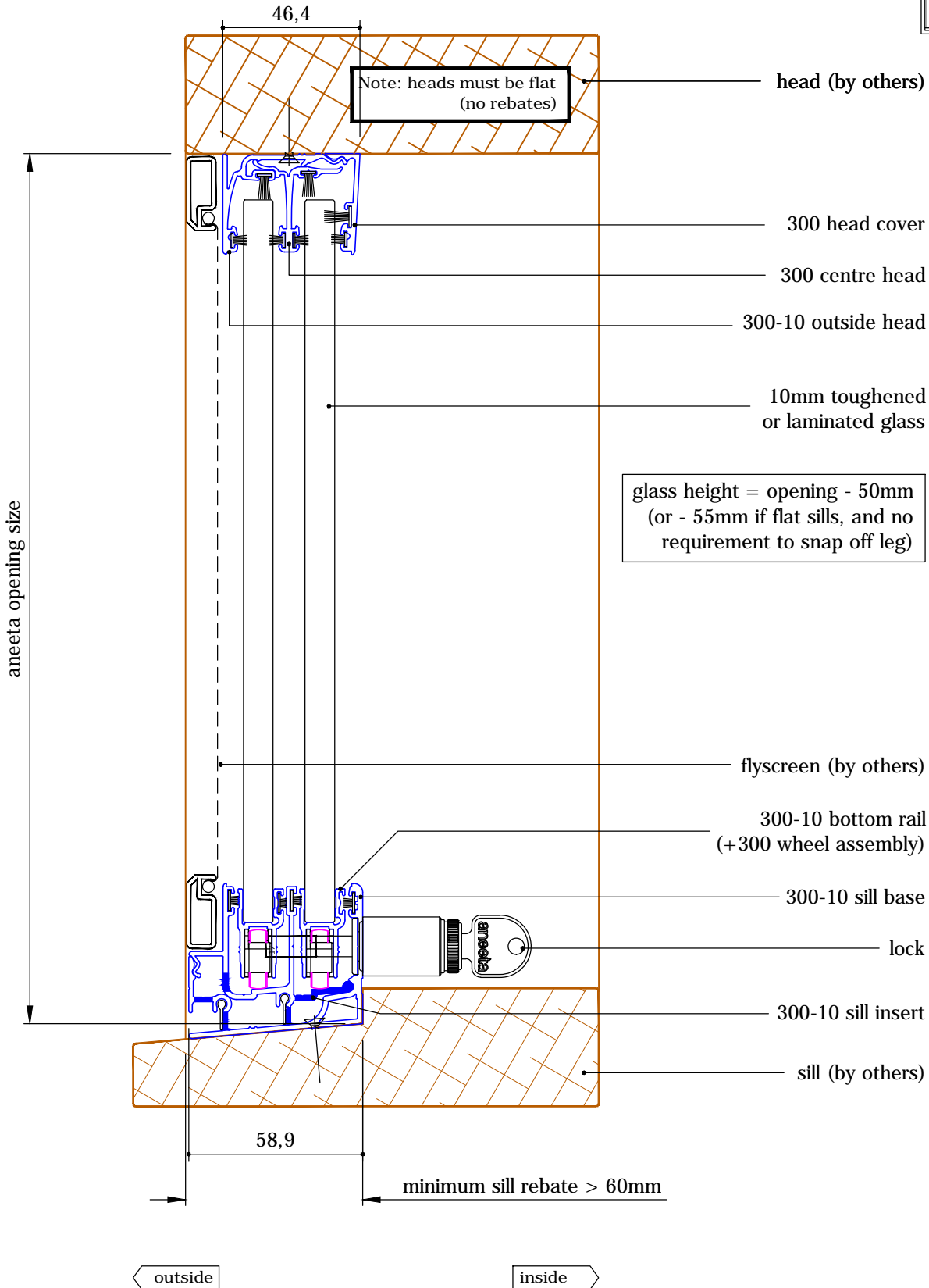
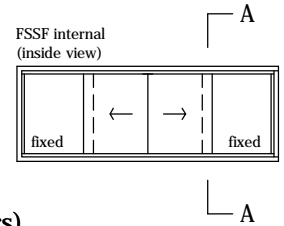

4 pane 10mm horizontal slider 300 series in timber frames, 2 panes fixed

horizontal section B-B

INTERNAL USE ONLY

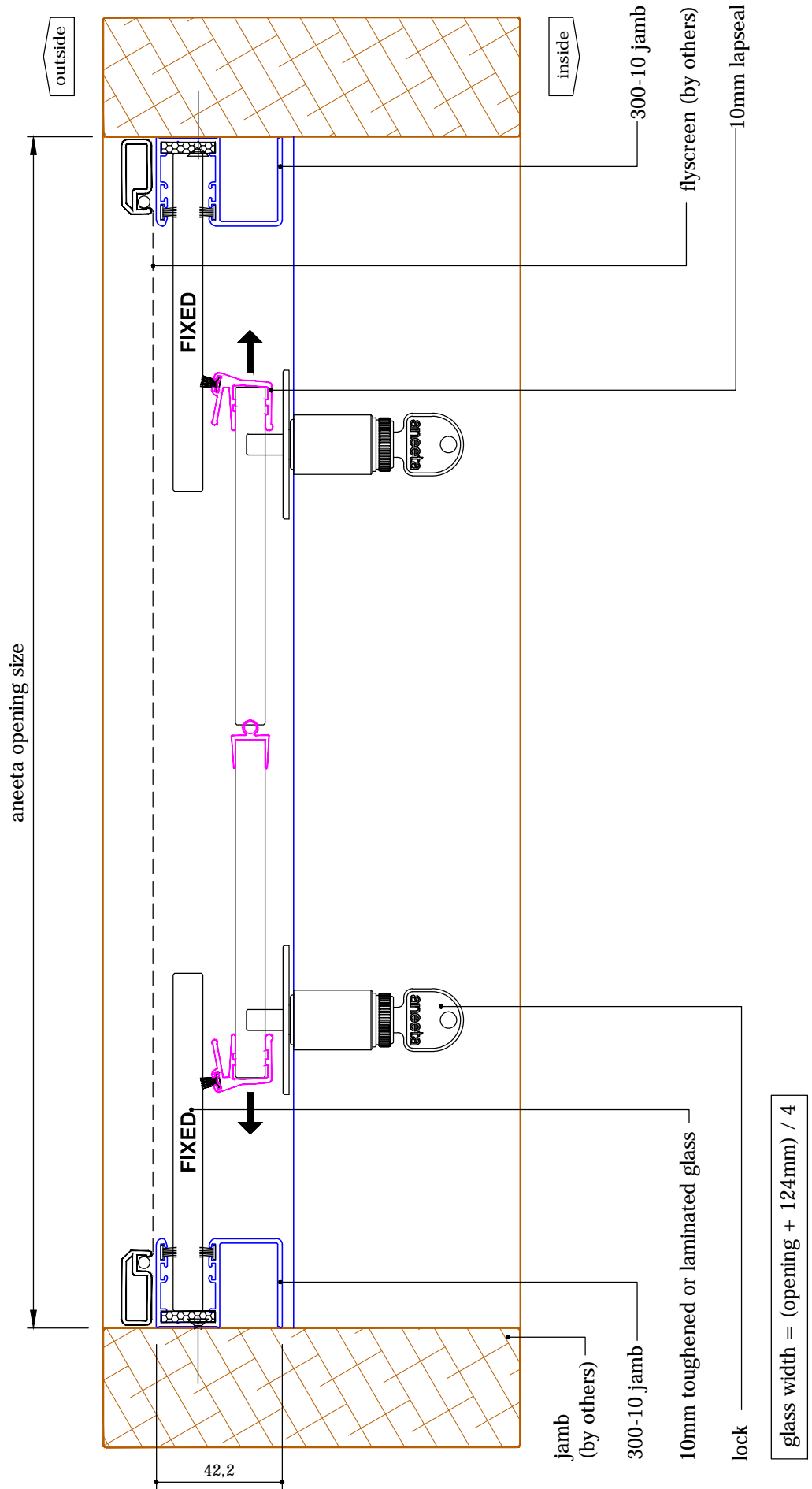
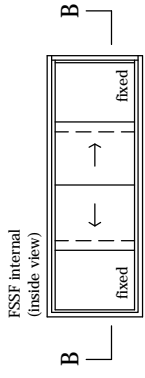

4 pane 10mm horizontal slider 300 series in timber frames, 2 panes fixed

vertical section A-A **INTERNAL USE ONLY**

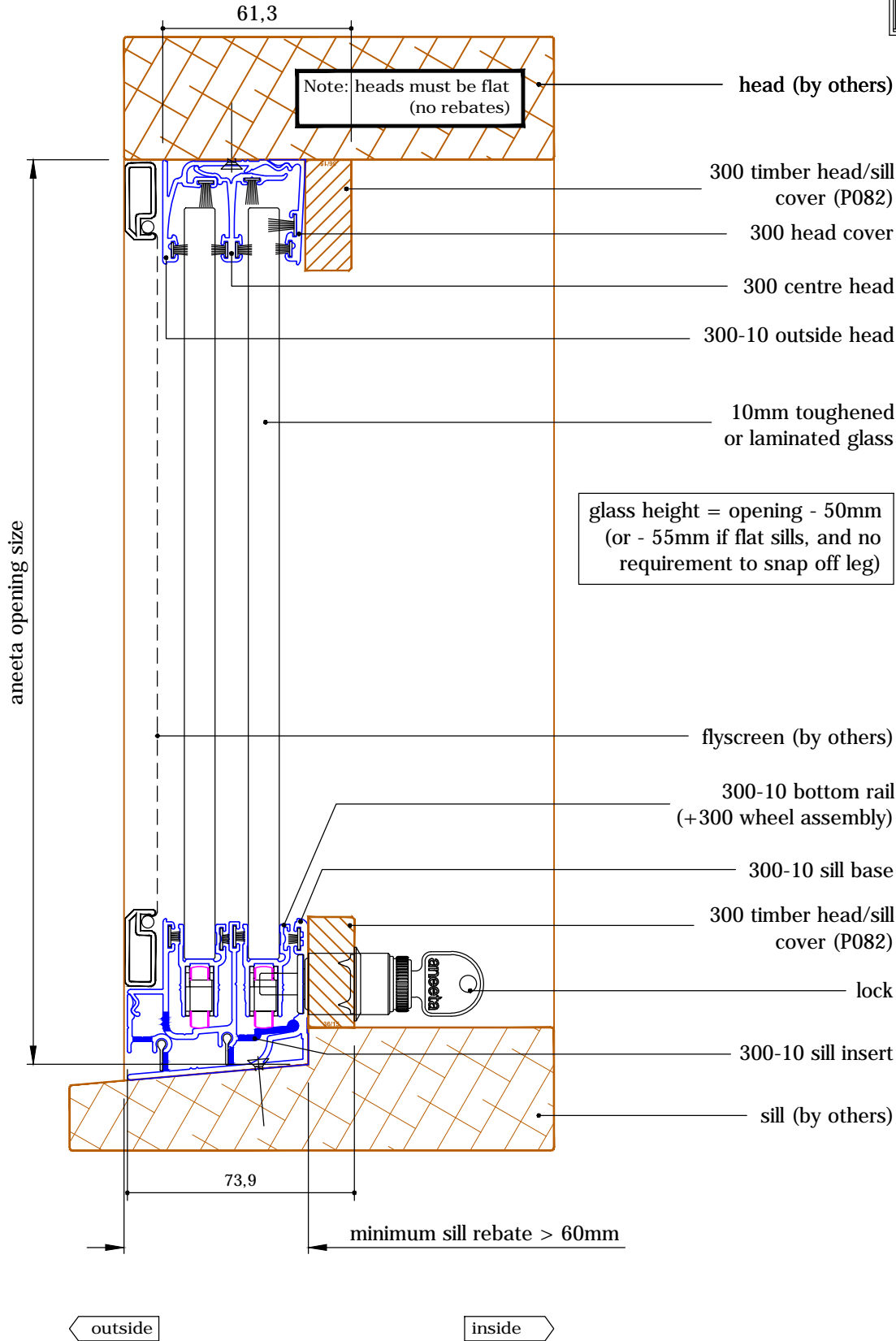
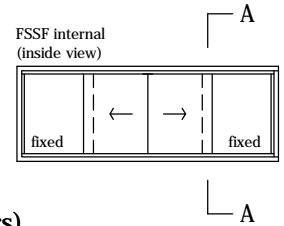

4 pane 10mm horizontal slider 300 series in timber frames, 2 panes fixed

horizontal section B-B
INTERNAL USE ONLY

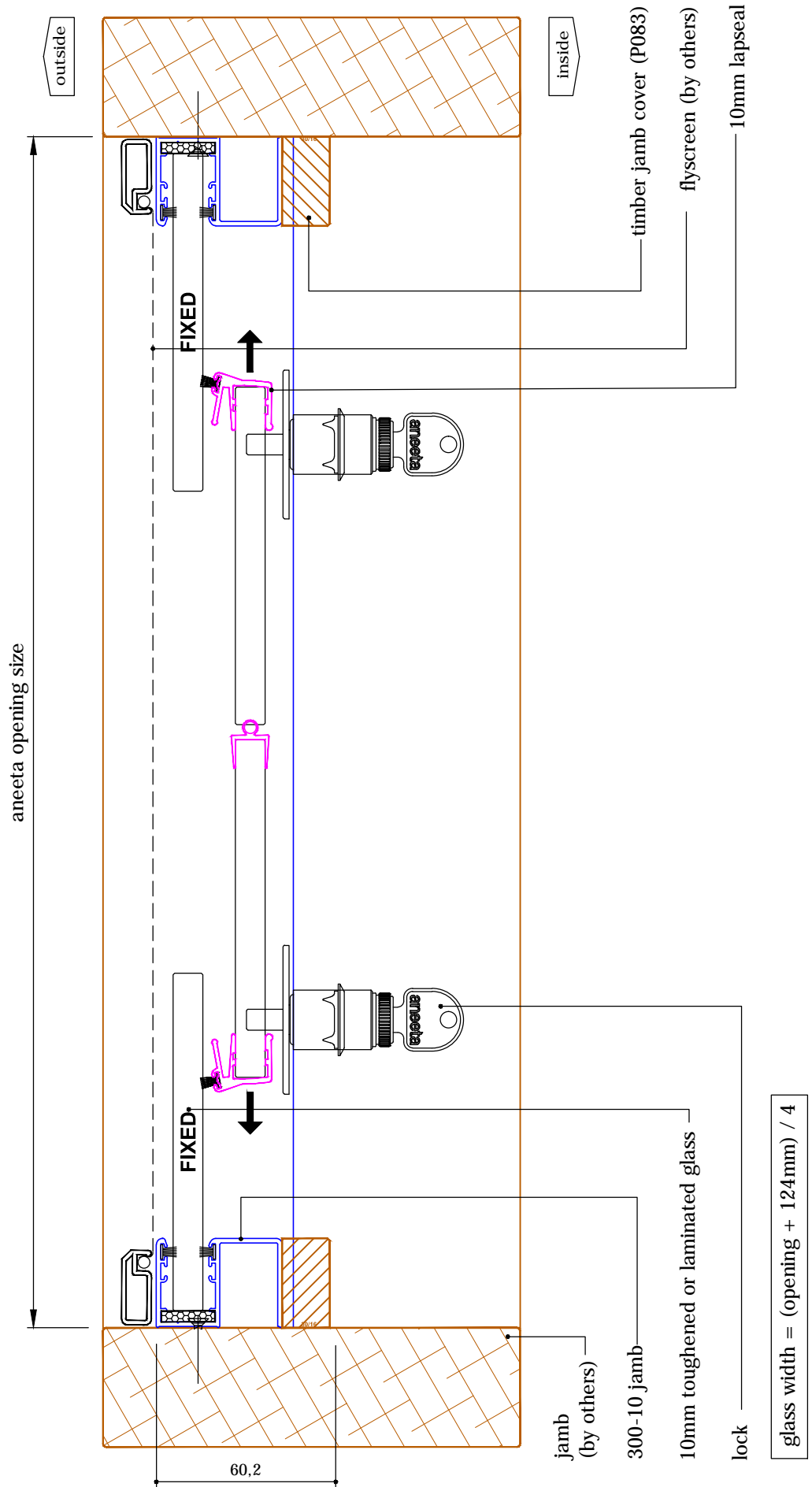
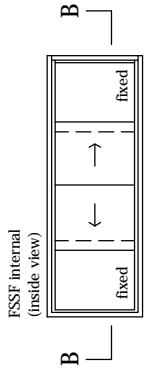

4 pane 10mm horizontal slider 300 series in timber frames, 2 panes fixed

vertical section A-A **INTERNAL USE ONLY**

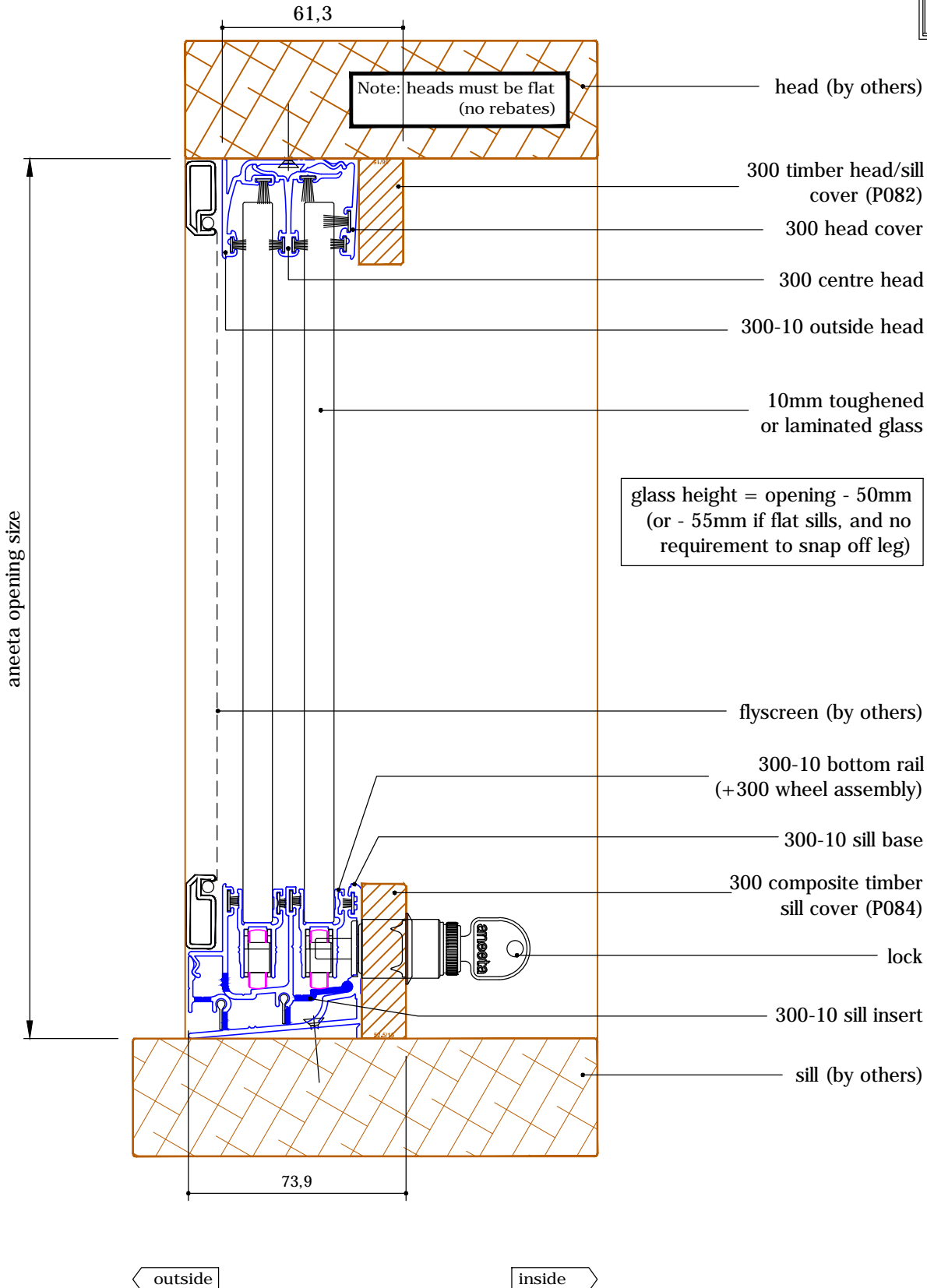
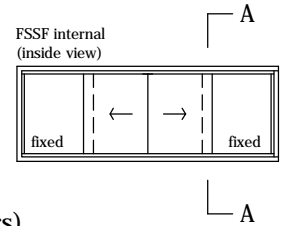

4 pane 10mm horizontal slider 300 series in timber frames, 2 panes fixed

horizontal section B-B

INTERNAL USE ONLY

